





WAX AND MODELLING INSTRUMENTS

STRUMENTI PER MODELLARE



583/1
P.K. Thomas N. 1



583/2
P.K. Thomas N. 2



583/3
P.K. Thomas N. 3



583/4
P.K. Thomas N. 4



583/5
P.K. Thomas N. 5



**Stainless steel
handle ø 6 mm**
Manico inox con
diametro ø 6 mm

583/SET
Set of 5 pieces P.K. Thomas on 977 tray
Set di 5 pezzi P.K. Thomas su vassoio 977



581/1

P.K. Thomas N. 1

Aluminium handle yellow
Manico in alluminio giallo

581/2

P.K. Thomas N. 2

Aluminium handle red
Manico in alluminio rosso

581/3

P.K. Thomas N. 3

Aluminium handle blue
Manico in alluminio blu

581/4

P.K. Thomas N. 4

Aluminium handle green
Manico in alluminio verde

581/5

P.K. Thomas N. 5

Aluminium handle silver
Manico in alluminio argento



**Aluminium handle anodized
in 5 colors ø 8 mm**

Manico in alluminio anodizzato
in 5 colori diametro ø 8 mm

581/SET

Set of 5 pieces P.K. Thomas on 977 tray
Set di 5 pezzi P.K. Thomas su vassoio 977



WAX KNIVES

COLTELLI PER CERA

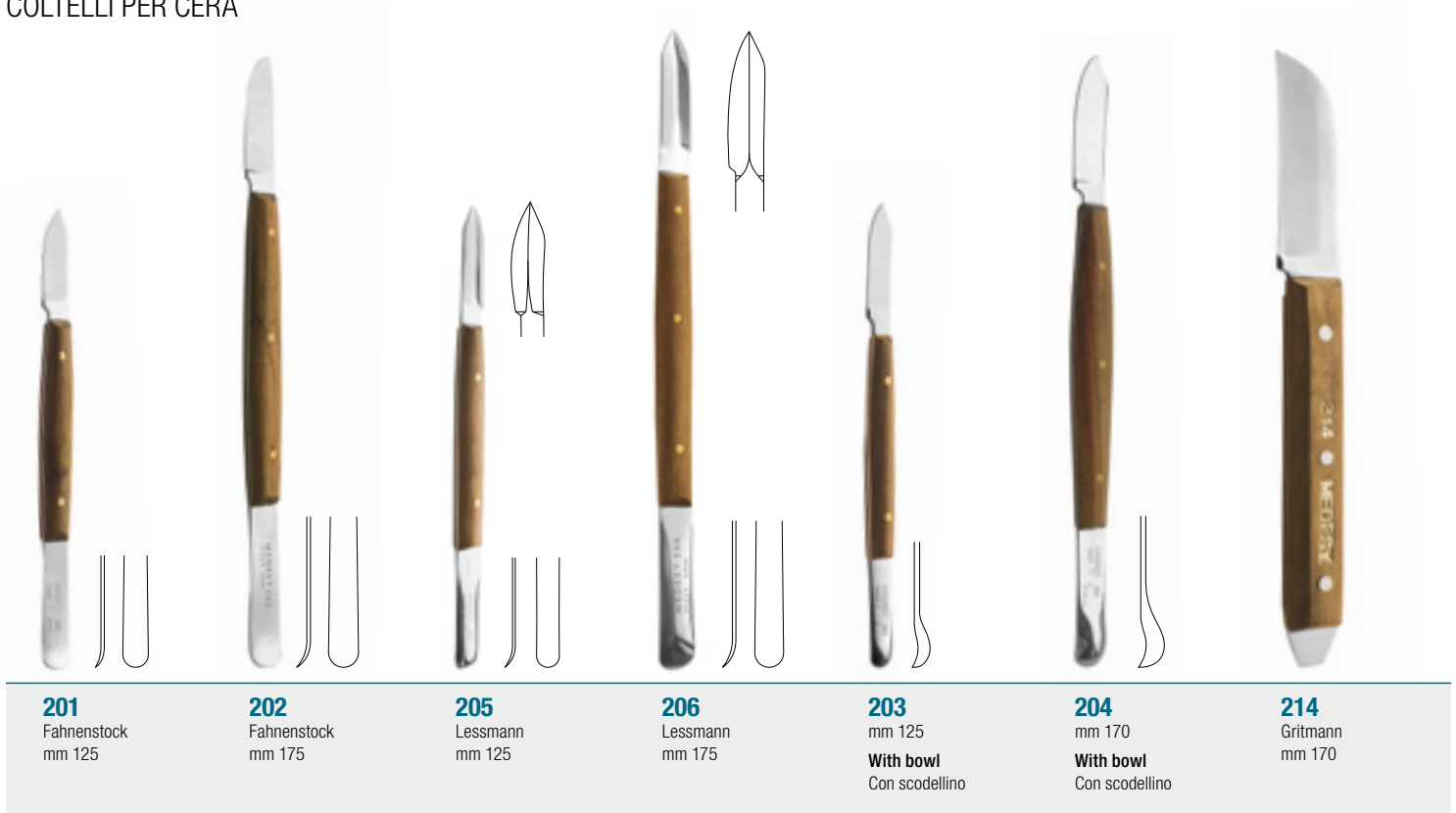

WAX AND MODELING INSTRUMENTS

STRUMENTI PER MODELLARE



599/SET

Set of wax and modeling instruments with insulated and autoclavable handle, on 977 tray

Set di strumenti per modellare con manico isolante ed autoclavabile, su vassoio 977

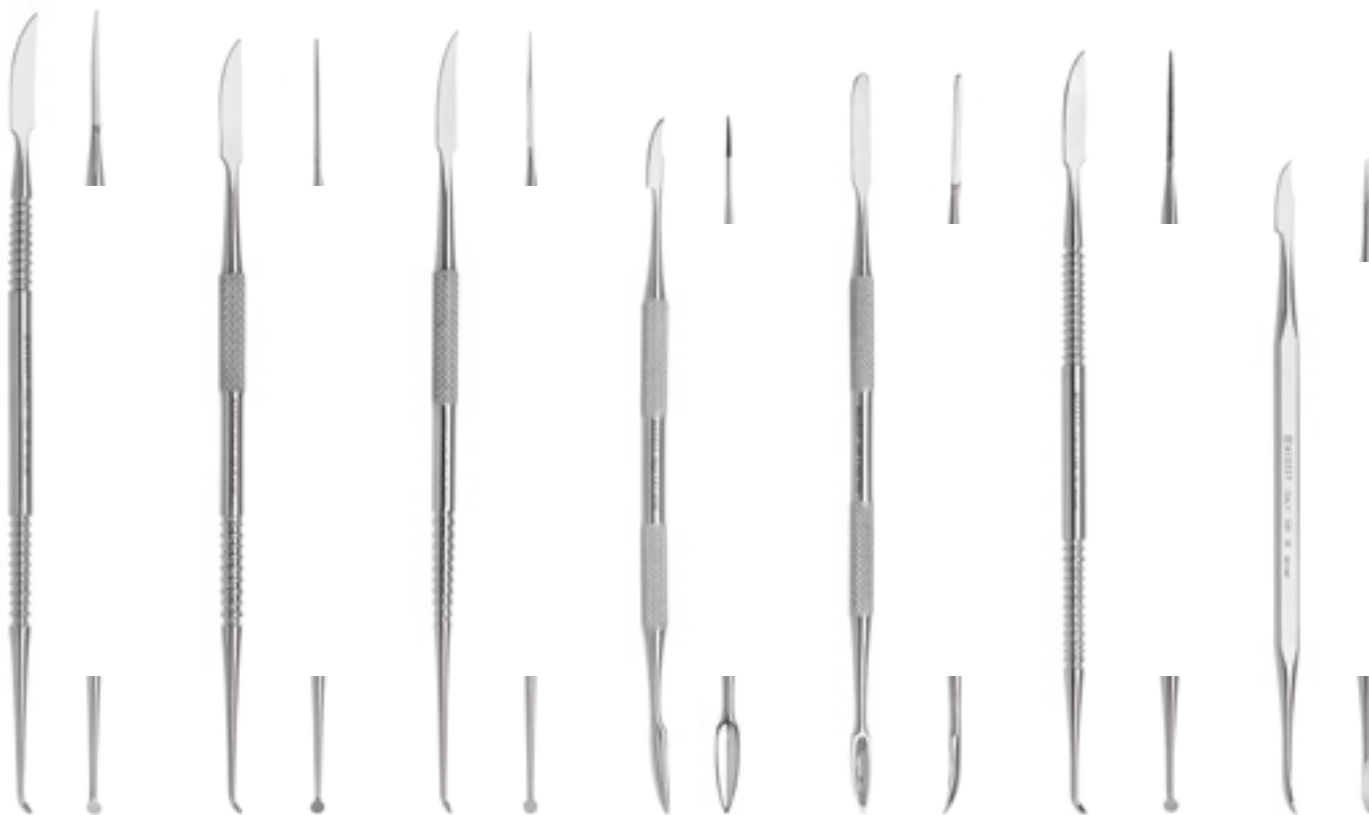

588 (mm 165)
Le Cron

589 (mm 160)
Le Cron

590 (mm 160)
Le Cron

597 (mm 145)
MSY

598 (mm 155)
MSY

599 (mm 160)
Le Cron

594 (mm 135)
Hylin



596 (mm 145)
Hylin

595 (mm 135)
Hylin

591 (mm 120)
Zahle

592 (mm 130)
Zahle

593 (mm 125)
Zahle

610 (mm 180)
Gritman



CEMENT SPATULAS

SPATOLE PER CEMENTI

(1:1 scale / scala 1:1)



676/24
Flexible
Flessibile

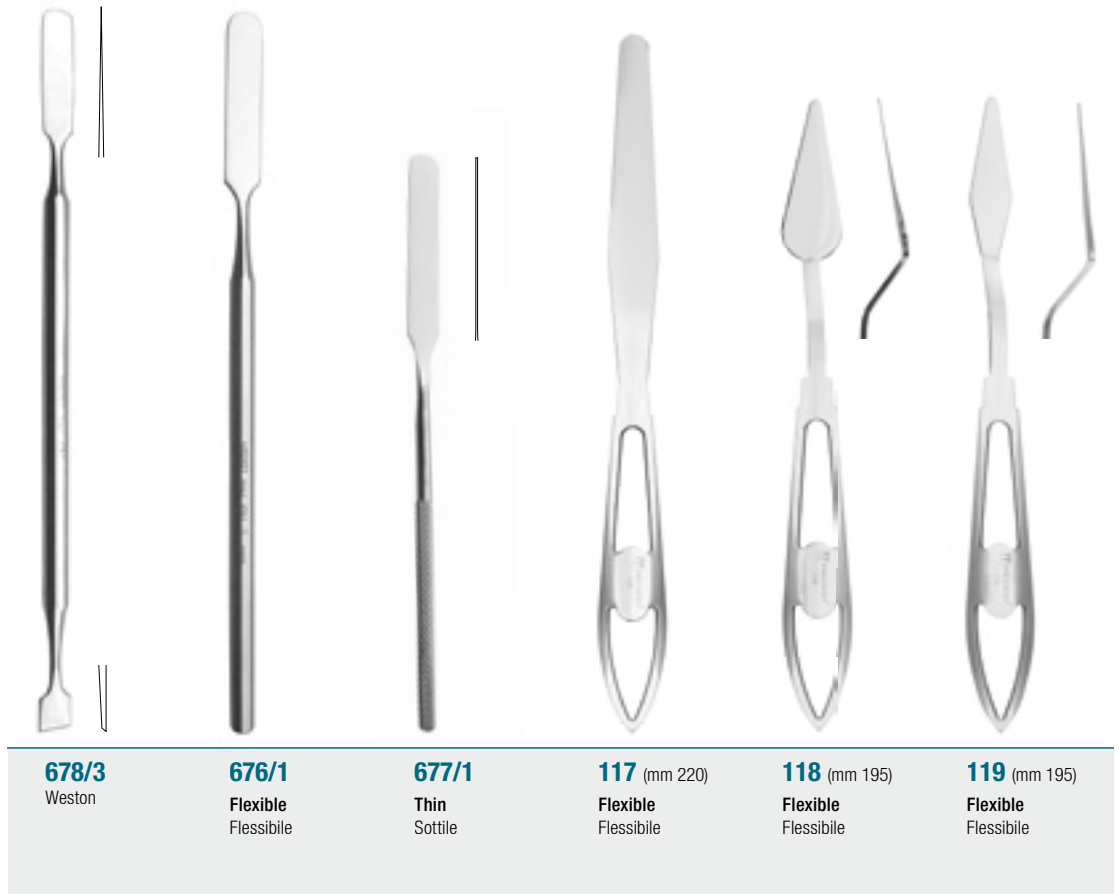
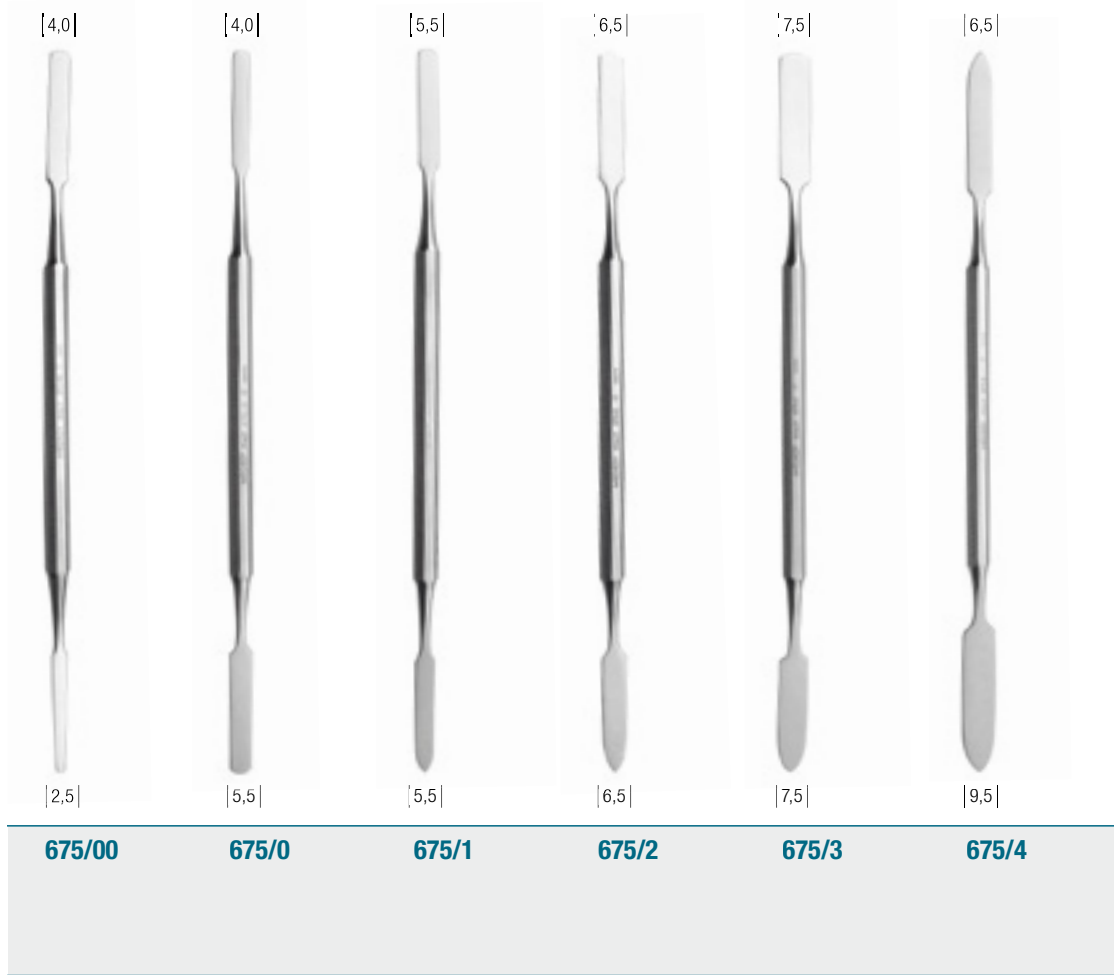

PLASTER AND ALGINATE SPATULAS

SPATOLE PER GESSO ED ALGINATO



208
mm 230
Spatula 8x
Spatola 8x



209
mm 215



210
mm 205



211
mm 200
Curved, rigid
Curva, rigida



213/2
mm 180
Rigid
Rigida



213
mm 180
Rigid
Rigida

ELASTOMERS ELASTOMERI



115
mm 190
Rigid
Rigida



116
mm 210
Flexible, assorted colors
Flessibile, colori assortiti



Cutting the spatulas from a stainless steel sheet.
Tranciatura delle spatole da un nastro di acciaio.



LABORATORY / LABORATORIO



CERAMICS SCULPTURING INSTRUMENTS

STRUMENTI PER CERAMICA

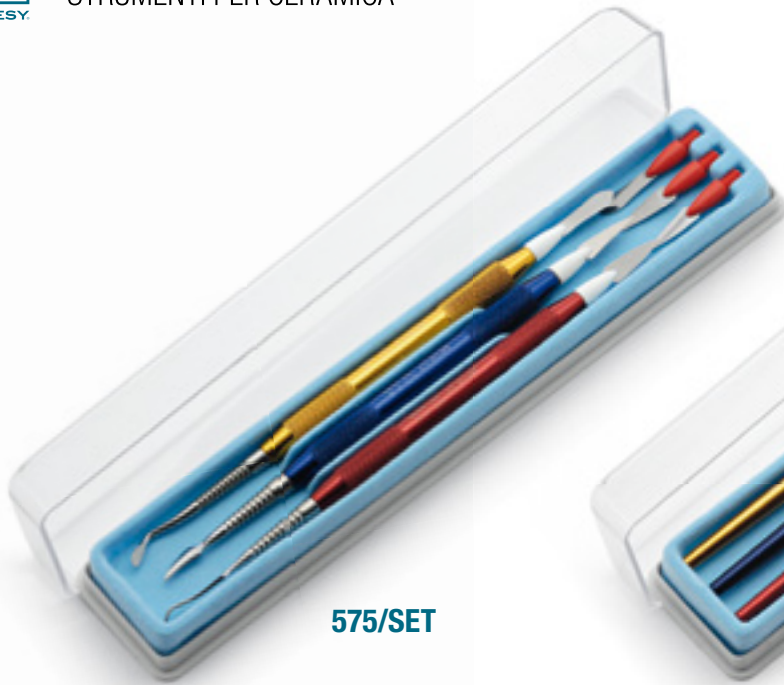

575/SET

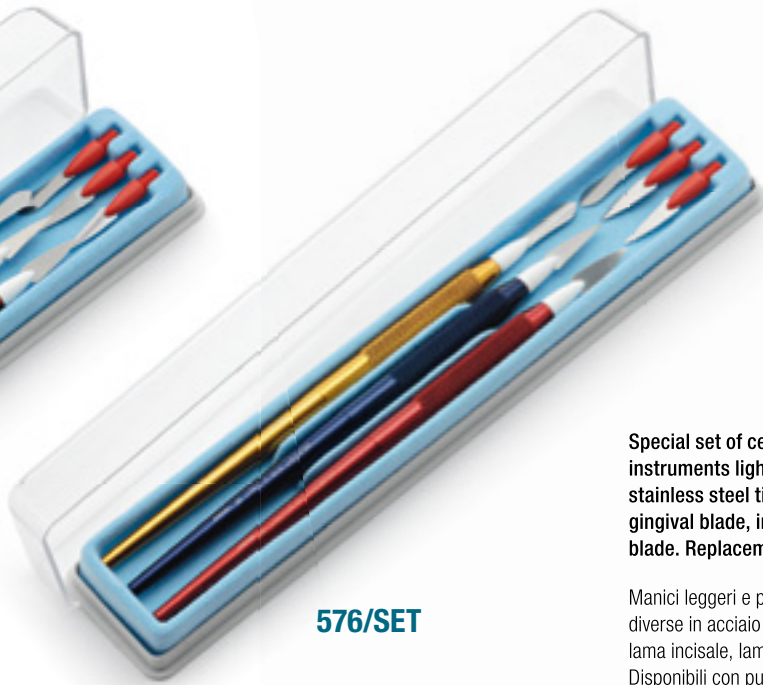

576/SET

Special set of ceramic sculpturing instruments light weight handles and stainless steel tips, different shape: gingival blade, incisal blade and knife blade. Replacement tips are available.

Manici leggeri e punte di forme diverse in acciaio inox, lama gengivale, lama incisale, lama coltello. Disponibili con puntali di ricambio.

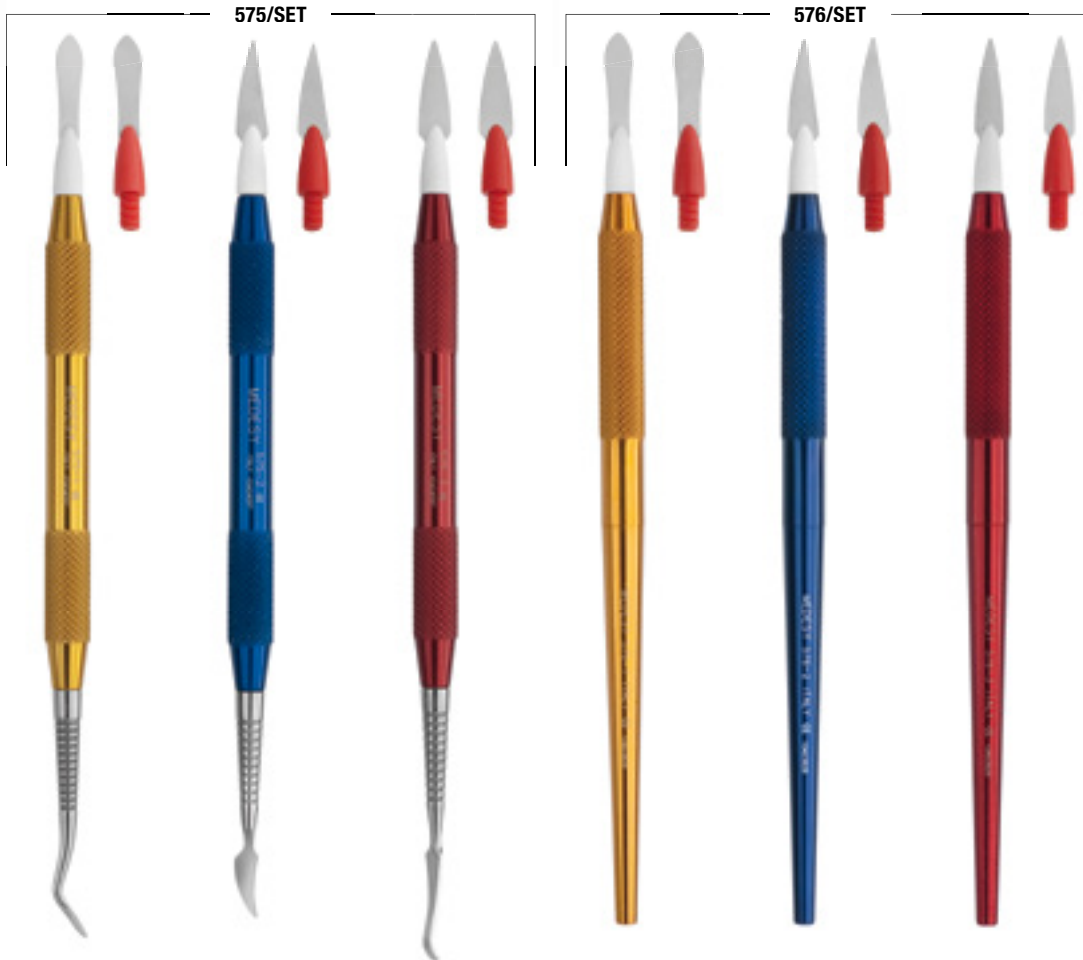

577/1-2-3
mm 0,1

Superflexible Tips
Puntali superflessibili



577/4-5-6
mm 0,2

Flexible Tips
Puntali flessibili

Both instruments are available with flexible or superflexible tips. Entrambi gli strumenti sono disponibili con puntali flessibili o superflessibili.

575/1

Aluminium handle
Yellow
Manico alluminio
Giallo

575/2

Aluminium handle
Blue
Manico alluminio
Blu

575/3

Aluminium handle
Red
Manico alluminio
Rosso

576/1

Aluminium handle
Yellow
Manico alluminio
Giallo

576/2

Aluminium handle
Blue
Manico alluminio
Blu

576/3

Aluminium handle
Red
Manico alluminio
Rosso

LABORATORY SET

SET PER PROTESI MOBILE E PER TECNICO



2105/SET

Contents / Contenuto

Art. 599 - 593 - 592 - 202 - 206 - 201 - 214 - 221 - 1519 - 3511 - 3522 - 3633 - 4981 - 2810.

“ MEDESYS IN SPOT

Content can be changed on request.
Il contenuto può essere cambiato a richiesta. ”

LABORATORY SET

SET PER CERAMICA E PROTESI FISSA



2100/SET

Contents / Contenuto

Art. 581/1 - 581/2 - 581/3 - 581/4 - 581/5 - 3511 - 1519 - 1024 - 3633 - 596 - 594 - 575/1 - 575/2 - 575/3



MALLETS – PLASTER SHEARS – SAWS

MARTELLETTI – CESOIE PER GESSO – SEGHETTI



949 (mm 200)
Horn tip
Punta in corno



947 (mm 220)
Metal tip
Punta in acciaio Inox



948 (mm 220)
Metal tip
Punta in acciaio Inox



4991/1
For plaster
Package 12 pcs
Per gesso
Sacchetti 12 pezzi

4991/2
For plaster
Package 12 pcs
Per gesso
Sacchetti 12 pezzi

4991 (mm 250)
Fret saw
Archetto

PLASTER SHEARS



4559 (mm 210)
Insulated handle
Manici in plastica

4558 (mm 200)



1645/1 (mm 250)
1645/2 (mm 320)
Crucible tongs
Pinza per cilindri e muffole



4990
mm 180



4990/3
mm 0,12x5
Package 12 pcs
Sacchetti da 12 pezzi



4990/2
mm 0,25x5
Package 12 pcs
Sacchetti da 12 pezzi



4990/1
mm 0,25x3
Package 12 pcs
Sacchetti da 12 pezzi

ARTICULATORS

ARTICOLATORI



Medesy new anatomic articulator, solidly manufactured in cast aluminium, about 400gr in weight. Projected and realized to ensure the largest visual field on the lingual surfaces as well as maintaining complete stability of the upper frame also at full open position: coiled springs facilitate the return to starting aligned position.

Technical details:

- Opening 125°
- Fixed condylar inclination of 30°
- Intercondylar distance of 110mm
- Incisal base inclination of 10°
- Bennet angle of 7°
- Distance between the mounting plates 85mm
- Spare parts available upon request

Questo è il nuovo articolatore anatomico di Medesy, prodotto in alluminio pressofuso dal peso di 400gr circa. È stato progettato e realizzato in modo da lasciar ampia visibilità alle superfici linguali, preservando la stabilità in posizione aperta: il ritorno in asse è agevolato grazie a delle molle di richiamo.

Dettagli tecnici:

- Apertura 125°
- Inclinazione condilare fissata a 30°
- Distanza intercondilare di 110mm
- Inclinazione base incisale 10°
- Angolo di Bennet fissato a 7°
- Distanza tra le piastre di montaggio 85mm
- Parti di ricambio su richiesta



5222

Articulator Medesy
Articolatore Medesy

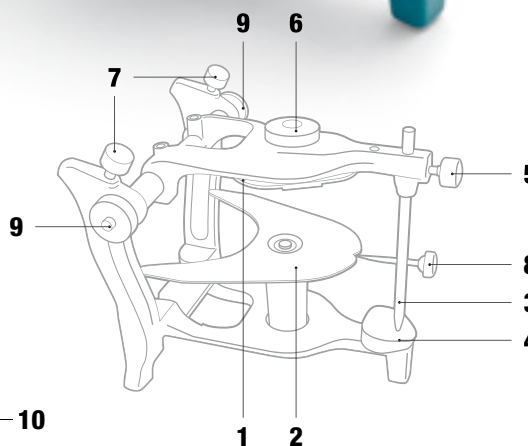

Complete Magnetic plate for articulator 5222 and related spare parts.
Piastra magnetica completa per articolatore 5222 e relativi ricambi.

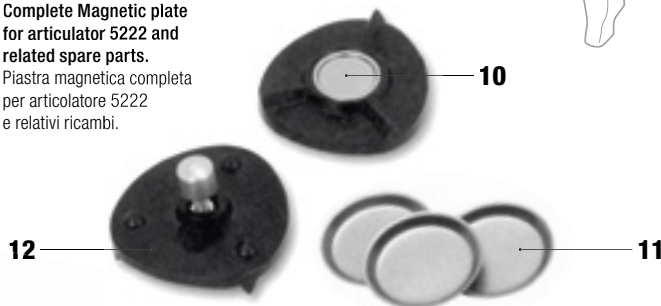

5224

Occluder Medesy
Occlusore Medesy

- | | |
|---|--|
| <p>1 5222/1
Mounting plates
Piastre di montaggio</p> <p>2 5222/2
Occlusal table
Piano di occlusione</p> <p>3 5222/3
Incisal guide pin
Asta incisale graduata</p> <p>4 5222/4
Incisal table 10°
Base incisale 10°</p> <p>5 5222/5
Incisal table and incisal guide pin lock screws
Viti per asta e base incisale</p> <p>6 5222/6
Mounting plates and occlusal table lock screws
Viti per piastre di montaggio e piano di occlusione</p> | <p>7 5222/7
Adjustable lateral excursion lock screws
Viti di bloccaggio movimenti laterali</p> <p>8 5222/8
Incisor indicator pin
Indicatore incisale</p> <p>9 5222/9
Upper jaw member screws
Viti per impugnatura movimenti laterali</p> <p>10 5222/10
Magnet
Magnete</p> <p>11 5222/11
Cast fastening washers
Ghiere per fissaggio modelli sul magnete</p> <p>12 5222/12
Complete magnetic plate
Piastra magnetica completa</p> |
|---|--|



STAINLESS STEEL REGULAR IMPRESSION TRAYS WITH RETENTION RIM

PORTAIMPRONTE FORATE REGOLARI INOX CON IL BORDINO RITENTIVO



6000/1UP



6000/4DR



6000/1LP



6000/4SL



Uppers / Superiori		Sizes / Misure (mm)				
6000	U1 XXS	U2 XS	U3 S	U4 M	U5 L	U6 XL
	56	65	68	71	73	78
	44	52	54	58	59	63

Lowers / Inferiori		Sizes / Misure (mm)				
6000	L1 XXS	L2 XS	L3 S	L4 M	L5 L	L6 XL
	56	66	70	73	76	78
	44	50	52	56	58	60

STAINLESS STEEL REGULAR IMPRESSION TRAYS WITHOUT RETENTION RIM

PORTAIMPRONTE FORATE REGOLARI INOX SENZA IL BORDINO RITENTIVO

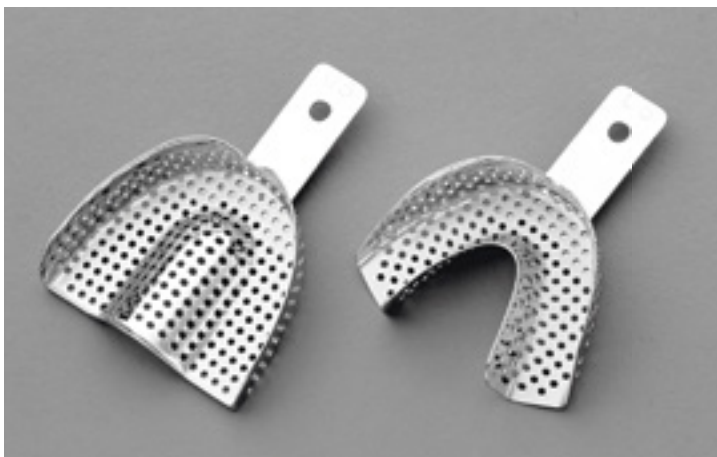

6000/KIT
6003/KIT

Contains 12 pcs
Contiene 12 pezzi



6003/4DR



6003/4SL



Uppers / Superiori		Sizes / Misure (mm)				
6003	U1 XXS	U2 XS	U3 S	U4 M	U5 L	U6 XL
	56	65	68	71	73	78
	44	52	54	58	59	63

Lowers / Inferiori		Sizes / Misure (mm)				
6003	L1 XXS	L2 XS	L3 S	L4 M	L5 L	L6 XL
	56	66	70	73	76	78
	44	50	52	56	58	60

STAINLESS STEEL ANATOMIC IMPRESSION TRAYS WITH RETENTION RIM

PORTAIMPRONTE ANATOMICHE INOX CON IL BORDINO RITENTIVO



6005/1UP



6005/4DR



6005/1LP



6005/4SL



Uppers / Superiori		Sizes / Misure (mm)				
6005	U1 XXS	U2 XS	U3 S	U4 M	U5 L	U6 XL
	56	65	68	71	73	78
	44	52	54	58	59	63

Lowers / Inferiori		Sizes / Misure (mm)				
6005	L1 XXS	L2 XS	L3 S	L4 M	L5 L	L6 XL
	56	66	70	73	76	78
	44	50	52	56	58	60



4955/P

Tips, spare part
Puntali di ricambio

4955

Syringe for elastomers, aluminium
Available in grey, red, blue, green
Siringa per elastomeri, alluminio
Disponibile in argento, rosso, blu, verde

4955/S

Brusher
Scovolino

6005/KIT

Contains 12 pcs
Contiene 12 pezzi





STAINLESS STEEL IMPRESSION TRAYS EDENTULOUS (COMPLETE DENTURE) SPECIAL FORM

PORTAIMPRONTE PER PROTESI TOTALI – EDENTULI INOX FORMA SPECIALE



		Uppers / Superiori			Sizes / Misure (mm)	
6009		U1 XXS	U2 XS	U3 S	U4 M	U5 L
		60	63	68	69	78
		51	52	58	59	63
		Lowers / Inferiori			Sizes / Misure (mm)	
6009		L1 XXS	L2 XS	L3 S	L4 M	L5 L
		60	67	70	74	75
		51	52	54	55	56

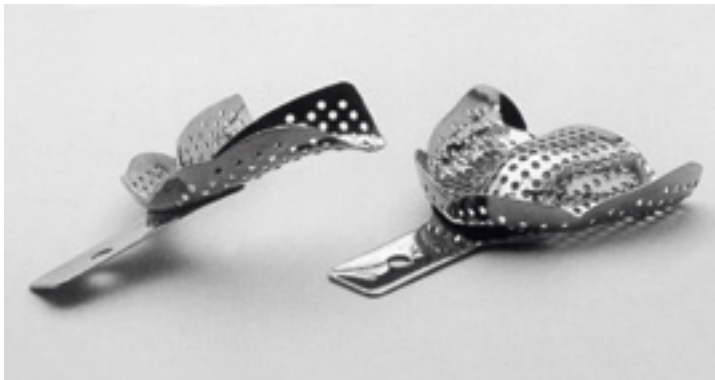

		Uppers / Superiori			Sizes / Misure (mm)	
6011		U1 XXS	U2 XS	U3 S	U4 M	U5 L
		60	63	68	69	78
		51	52	58	59	63
		Lowers / Inferiori			Sizes / Misure (mm)	
6011		L1 XXS	L2 XS	L3 S	L4 M	L5 L
		60	67	70	74	75
		51	52	54	55	56

6009/KIT
6011/KIT

Contains 11 pcs
Contiene 11 pezzi

ALUMINIUM PERFORATED IMPRESSION TRAYS

PORTAIMPRONTE PERFORATE IN ALLUMINIO

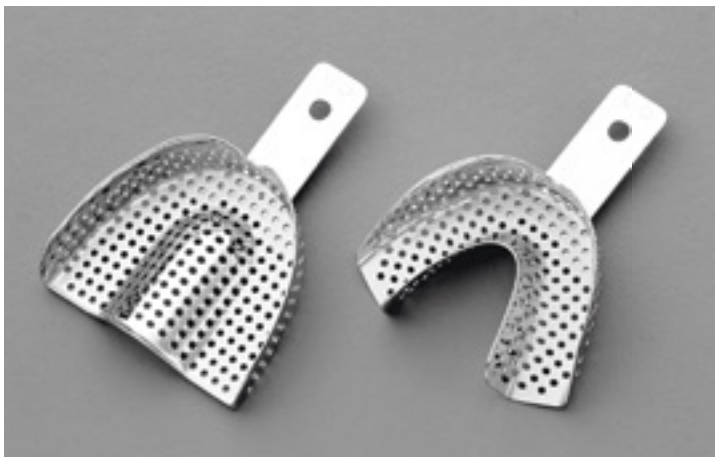

6006/4DR

6006/4SL



		Uppers / Superiori			Sizes / Misure (mm)	
6006		U1 XXS	U2 XS	U3 S	U4 M	U5 L
		64	66	69	72	74
		49	51	54	58	61

		Lowers / Inferiori			Sizes / Misure (mm)	
6006		L1 XXS	L2 XS	L3 S	L4 M	L5 L
		55	59	71	75	77
		48	50	52	56	58

EHRICKE STAINLESS STEEL IMPRESSION TRAYS

PORTAIMPRONTE IN ACCIAIO INOX MODELLO EHRICKE



6002/KIT

Partially toothed
Per arcate parzialmente dentate

Only available
in kit 4 pcs

Disponibile solo
in kit 4 pezzi

Uppers / Superiori		Sizes / Misure (mm)	
6002	U1	U2	
	62	70	
	50	56	
Lowers / Inferiori		Sizes / Misure (mm)	
6002	L1	L2	
	70	78	
	55	59	



6010/KIT

Edentulous jaws
Per arcate edentule

Only available
in kit 6 pcs

Disponibile solo
in kit 6 pezzi

Uppers / Superiori		Sizes / Misure (mm)		
6010	U1	U2	U3	
	64	68	79	
	46	53	61	
Lowers / Inferiori		Sizes / Misure (mm)		
6010	L1	L2	L3	
	70	70	72	
	48	53	57	

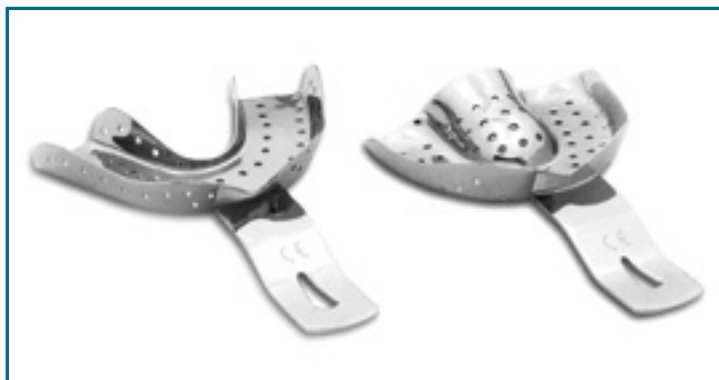

6001/KIT

Toothed jaws
Per arcate dentate

Only available
in kit 10 pcs

Disponibile solo
in kit 10 pezzi

Uppers / Superiori		Sizes / Misure (mm)				
6001	U1	U2	U3	U4	U5	
	XXS	XS	S	M	L	
	59	66	71	71	80	
	52	52	62	64	70	
Lowers / Inferiori		Sizes / Misure (mm)				
6001	L1	L2	L3	L4	L5	
	XXS	XS	S	M	L	
	65	67	76	79	79	
	46	50	54	56	61	



6012/UCB

For narrow toothed
upper jaws
Per arcate superiori
strette dentate



Uppers / Superiori		Sizes / Misure (mm)
6012	UCB	
	70	
	54	





STAINLESS STEEL EDENTULOUS (COMPLETE DENTURE) RIM LOCK

PORTAIMPRONTE PER PROTESI TOTALI EDENTULI INOX CON IL BORDINO RITENTIVO



Uppers / Superiori	Sizes / Misure (mm)			
6013	U1 S	U2 M	U3 L	U4 XL
	64	65	73	76
	68	58	58	57

Loweres / Inferiori	Sizes / Misure (mm)			
6013	L1 S	L2 M	L3 L	L4 XL
	66	72	76	82
	54	56	60	61





6013/KIT



Contains 8 pcs
Contiene 8 pezzi

STAINLESS STEEL EDENTULOUS (COMPLETE DENTURE) PERFORATED RIM LOCK

PORTAIMPRONTE PER PROTESI TOTALI EDENTULI INOX FORATE CON IL BORDINO RITENTIVO



Uppers / Superiori	Sizes / Misure (mm)			
6014	U1 S	U2 M	U3 L	U4 XL
	65	66	72	77
	58	63	61	68

Loweres / Inferiori	Sizes / Misure (mm)			
6014	L1 S	L2 M	L3 L	L4 XL
	65	72	75	83
	56	60	61	62



6014/KIT

Contains 8 pcs
Contiene 8 pezzi

STAINLESS STEEL ORTHODONTIC (CHILDREN) RIM LOCK

PORTAIMPRONTE ORTODONTICHE INOX CON IL BORDINO RITENTIVO



Uppers / Superiori		Sizes / Misure (mm)			
6017	U1 S	U2 M	U3 L	U4 XL	
	52	58	59	60	
	41	42	49	50	

Lowers / Inferiori		Sizes / Misure (mm)			
6017	L1 S	L2 M	L3 L	L4 XL	
	57	62	69	70	
	42	48	49	50	

6017/KIT

Contains 8 pcs
Contiene 8 pezzi

STAINLESS STEEL ORTHODONTIC (CHILDREN) PERFORATED RIM LOCK

PORTAIMPRONTE ORTODONTICHE INOX PERFORATE CON IL BORDINO RITENTIVO



Uppers / Superiori		Sizes / Misure (mm)			
6018	U1 S	U2 M	U3 L	U4 XL	
	52	58	59	60	
	41	42	49	50	

Lowers / Inferiori		Sizes / Misure (mm)			
6018	L1 S	L2 M	L3 L	L4 XL	
	57	62	69	70	
	42	48	49	50	

6018/KIT

Contains 8 pcs
Contiene 8 pezzi



LABORATORY / LABORATORIO

DISPOSABLES IMPRESSION TRAYS

PORTAIMPRONTE MONOUSO







6007/24

Set of 24 assorted pieces
Confezione da 24 pz. assortiti

6007/100

Set of 100 assorted pieces
Confezione da 100 pz. assortiti



Uppers / Superiori		Sizes / Misure (mm)		
6007	U1 XXS	U2 XS	U3 S	U4 M
	61	65	70	73
	49	53	59	63
Lowers / Inferiori		Sizes / Misure (mm)		
6007	L1 XXS	L2 XS	L3 S	L4 M
	61	67	72	74
	50	52	56	58

POLYCARBONATE IMPRESSION TRAYS

PORTAIMPRONTE IN POLICARBONATO



6008/24 KIT

Series of 24 polycarbonate
impression trays and compasses
for final impressions

Serie di 24 portaimpronte in
policarbonato più compasso
per impronte definitive

For edentulous or partially toothed bites,
autoclavable (more info upon request)

Per bocche edentule o parzialmente dentate,
autoclavabile (su richiesta maggiori informazioni)

STAINLESS STEEL REGULAR IMPRESSION TRAYS WITH RETENTION RIM – SATIN FINISH

PORTAIMPRONTE FORATE REGOLARI INOX CON IL BORDINO RITENTIVO, SATINATE



6000/KIT-SB



New micro sandblasted surface on the stainless steel impression trays of range 6000: the special treatment ensures a higher adhesion of the impression materials and thus a finest quality of the final imprint.

Nuova superficie micro sabbata per le portaimpronte in acciaio inox della serie 6000: tale trattamento assicura una migliore adesione del materiale da impronta e conseguentemente la qualità del lavoro finale.

FORCEPS FOR ARTICULATING PAPER PINZE PER CARTA DI ARTICOLAZIONI



4584
mm 155

4583
Miller
mm 155

4585
mm 140

Full arch paper holder
Pinze per carta di articolazione

SOLDERING TWEEZERS PINZETTE PER SALDATURA



Fiber handles
Manico in fibra

221
mm 165

Straight
Retta

222
mm 160

Curved
Curva



LABORATORY / LABORATORIO



4983 (mm 130)
Beerendonk



4984 (mm 130)
Zürcher



4982 (mm 145)
Boley



4980/C



4981/M



4980/C (For wax / Per cera)
4981/M (For metal / Per metallo)
Iwanson
mm 100



4988 (mm 150)
Steel ruler
Righello in acciaio



4985 (mm 130)
Caliper flat
Calibro piatto

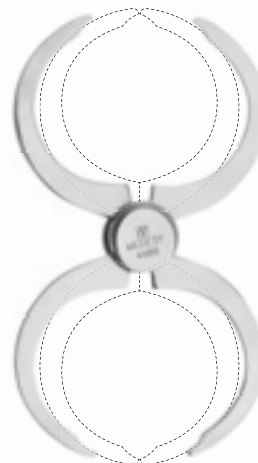

4986
Caliper compass
Calibro a compasso

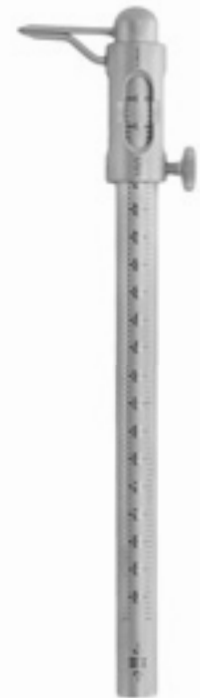

4989 (mm 125)
Caliper Medesy
Calibro Medesy